

Mi·Light® User Instruction











 5 IN 1 WiFi LED Controller
 Model No.: YL5

Please read the instructions carefully before using the controller.

1. Features

The controller is adopted by the most advanced PWM control technology, and has memory function(The light status will keep same as the status before you turn off the light);Wireless and 4G controlled by Mi-light Cloud APP.

-  Support Amazon Alexa Voice Control
-  WiFi Wireless Control
-  Smart phone App control
-  Compatible with 2.4GHz RF Remote Controller
-  RGB colors to choose
-  Dimmable Saturation control
-  Color temperature 2700-6500K
-  Timing ON/OFF the lights
-  Group control randomly by APP
-  16 Color Changing modes

2. Parameters

Model No.: YL5
 Input Voltage: DC12V~24V (5.5*2.1mm)
 Output: 6A/Channel (Total Output Max. 15A)
 Working Temperature: -20~60 C
 Control Distance: 30m
 Communication Mode: WiFi-IEEE 802.11b/g/n 2.4GHz or 2.4G RF
 Weight: 65g

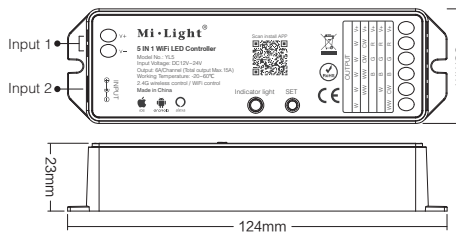

SET Button: Long press "SET" for 3 seconds; When red indicating light blink quickly, device reset and go into Smart Link mode.

Indicating light instruction:

Red light always-on	Red light blinking	Green light always-on
Disconnected from network	Smart Link Mode	Networking successfully

3. Auto-synchronization function

Different controllers can work synchronously when they are started at different times, controlled by the same remote, under same dynamic mode and with same speed.

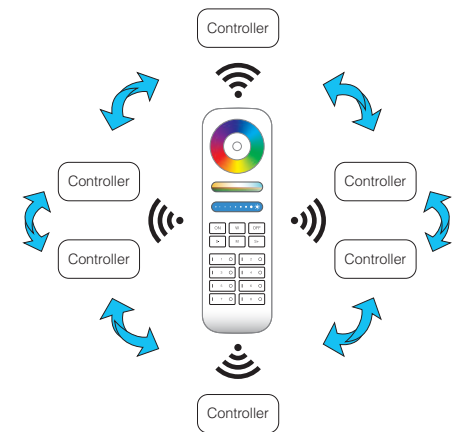

Remark:

- Indicating Auto-transmitting.
- Controller will be auto-synchronizing in the same dynamic modes and within 30m controlling distance.

4. Auto-transmitting Diagram

One strip controller can transmit the signals from the remote control to another controller within 30m, as long as there is a strip controller within 30m, the remote control distance can be limitless.

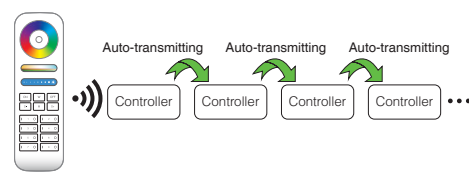

5. Connect to LED strip diagram

 Controller input voltage must be in accordance with the required voltage of LED Strips.

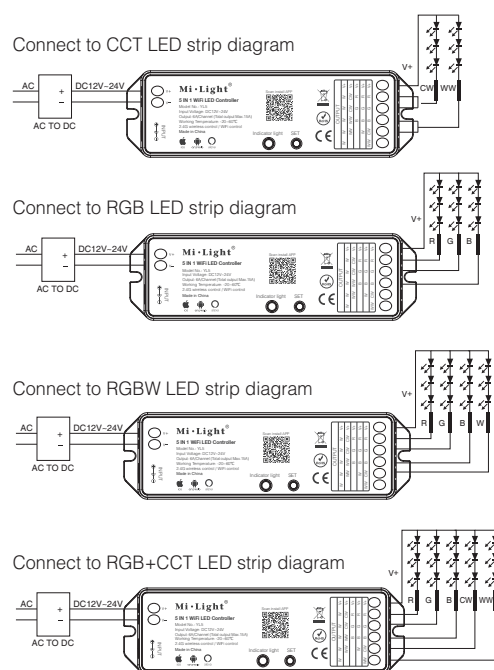

6. Remote Controller

Compatible with these remote controls (Purchased separately). For more details, pls read the remote instruction.

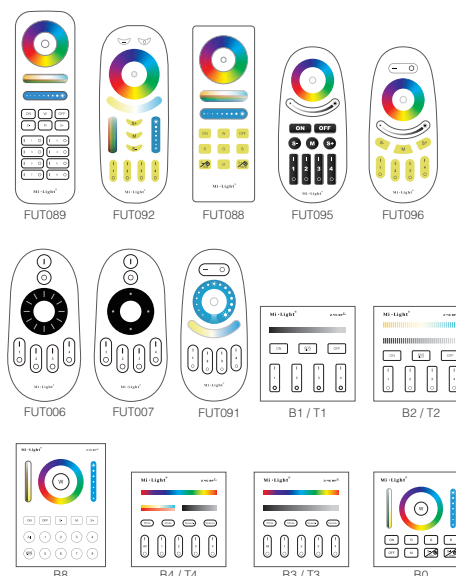

Attention

- Please check whether the input voltage of the constant voltage power supply is in accordance with the controller, and please check the connection of both the cathode and anode.
- The working Voltage is DC12~24V, the controller will be broken if the voltage is higher than 24V.
- Non-professional user cannot dismantle the controller directly, otherwise, it may cause fire and electric shock.
- The working temperature is -20~60°C; Do not use the device to direct sunlight, moist and other high temperature area.
- Please do not use controller around the mental area and high magnetic field, otherwise, it will badly affect the control distance.



Mi-Light Cloud APP User Instruction

1 APP Downloading

For IOS System: Pls search "Mi-Light Cloud" on APP store. (Above IOS9.0)

For Android System: search "Mi-Light Cloud" on Google Play (Above Android 5.0) or Scan below QR-code to download APP.



Scan QR Code to install APP



2 Register Mi-Light Cloud Account

Open APP and click Register button; Complete the register and log in.

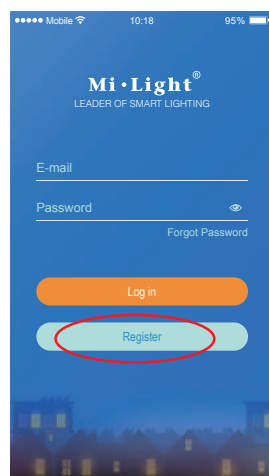

3 Add Device

- Click the right top "+" on the device list.
- Please select the device type you will add, then complete the adding according to the hint of APP.
- Back to device list after adding successfully, then pull down refresh in list to get the device status.

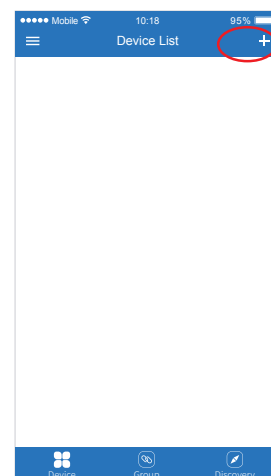



4 Modify device name or delete device

Slide device list to left, click "Edit" to modify device name; click "Delete" to delete device.

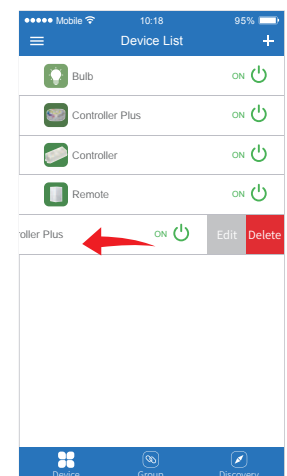
Note: If the device was shared to others, then the device will also be deleted on your friends' device list.



5 Group Control

- Click  to switch to Group list, then click the right top  icon on the Group list to create groups.
- Slide the Group list to left to **Edit/Delete** groups.

Note: The group just work on APP Controlling, cannot work on Voice control. Please open Amazon APP for Group Voice control.

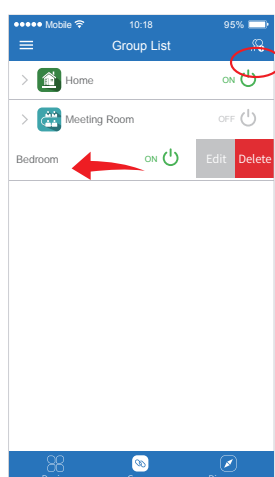

6 APP Control

Click the device or group that you want to dim on device list and group list into Dimming Interface.

 Click Speed+ under dynamic mode

 Click Speed- under dynamic mode.

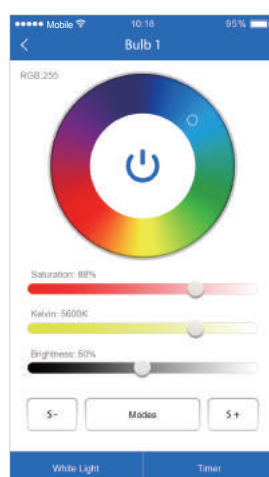

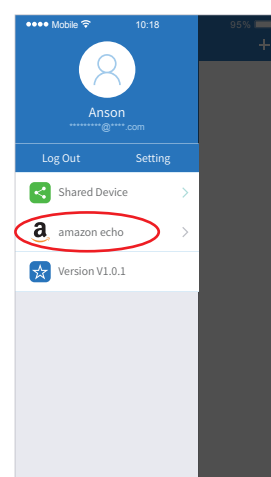

7 Amazon echo Voice Control

Click left top  icon on the home page
Then click  to check detailed instructions



8 Sharing Device

Share the device to friends, Let your friends can control this device.

- Click the left top  icon on the home page.
- Click  Shared Device * to My sharing, then click "Add sharing" (Note: the receiving sharing device cannot be shared again).
- Click  * to edit sharing, slide to left to delete sharing.

